

E (u) 2: M 1:10

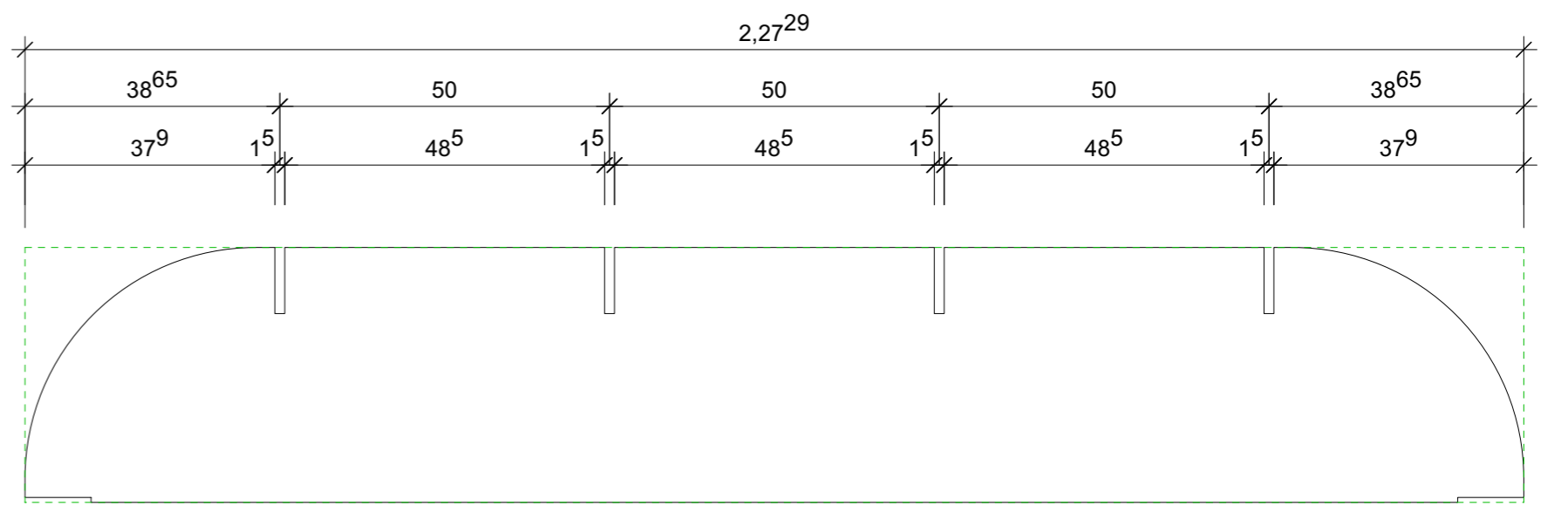

E (o) 2: M 1:10

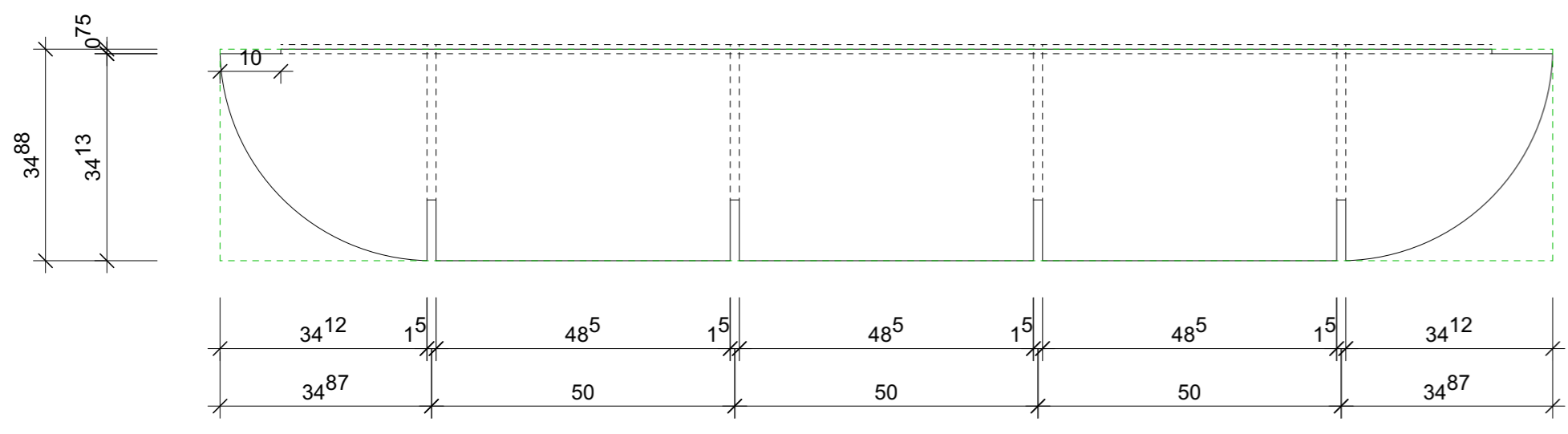

E (u) 1: M 1:10

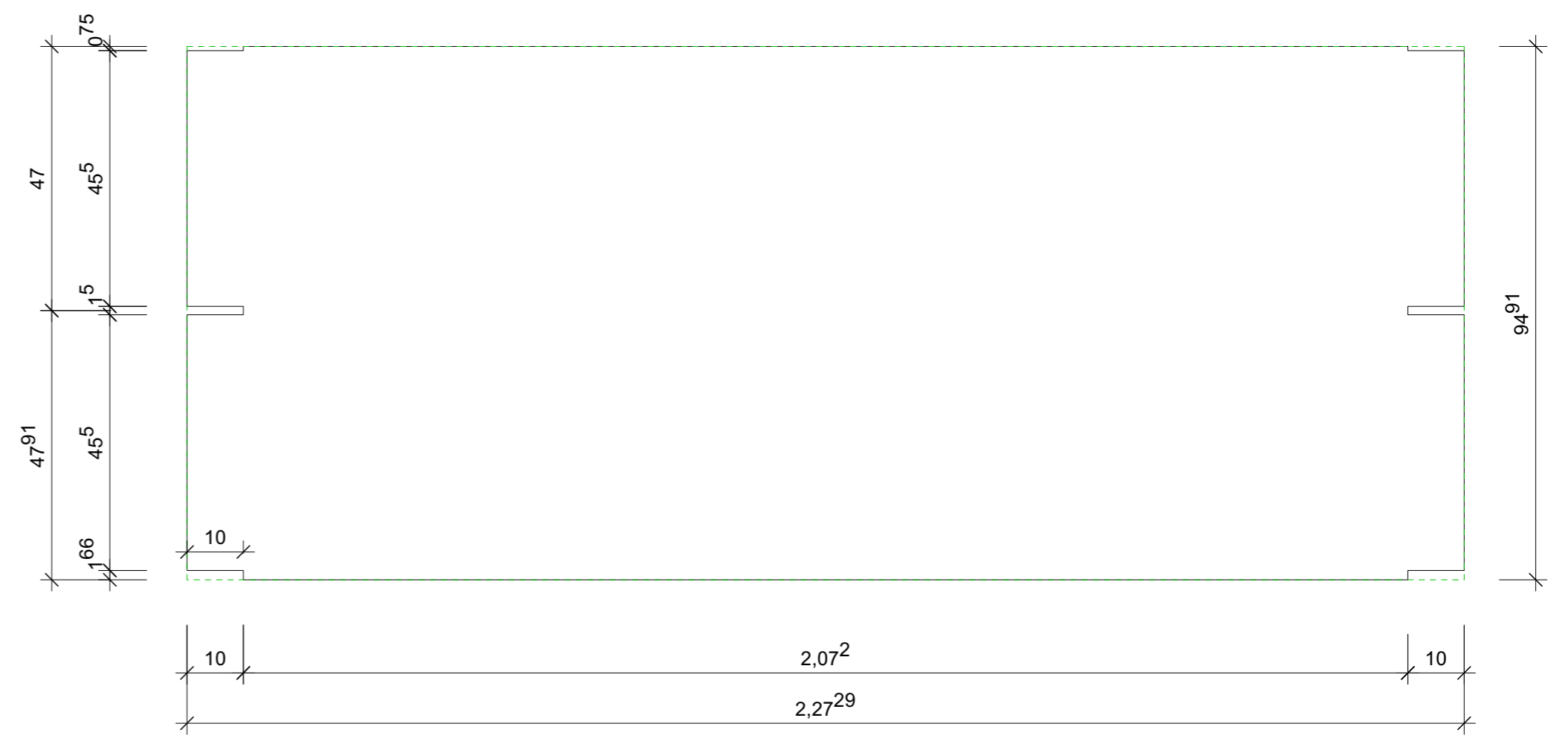

E (o) 1: M 1:10

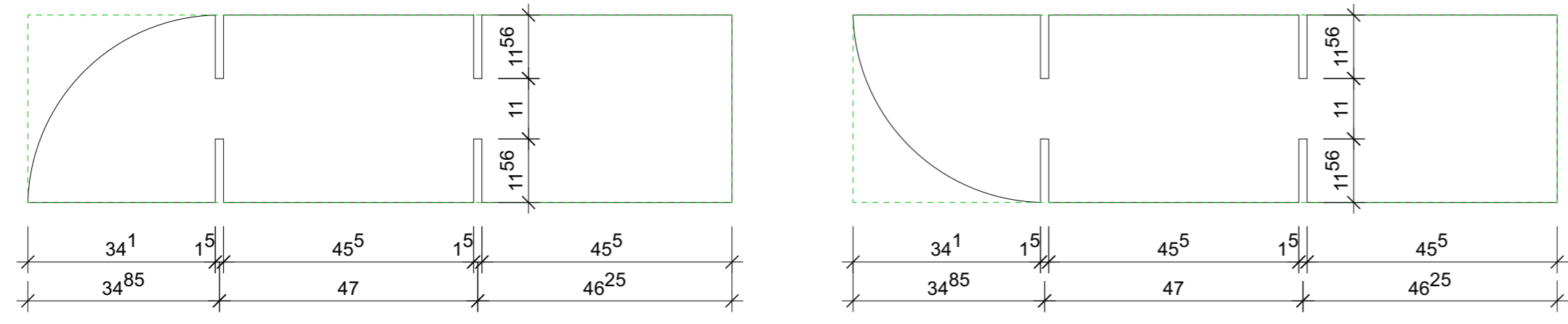

E (u) 3: M 1:10

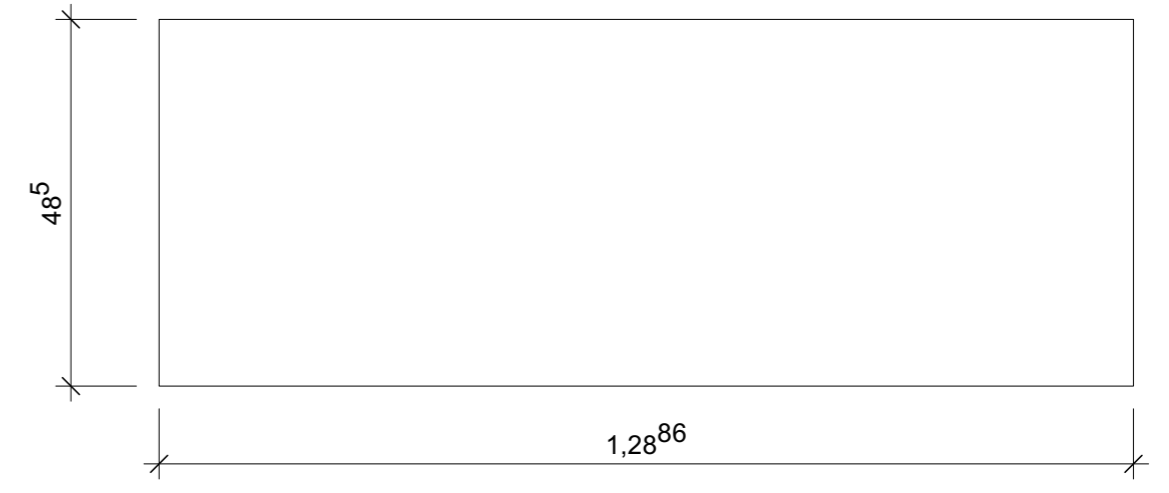

E (u) 4: M 1:10

E (u) 1/2

Pl.Nr.: K-09
 Anzahl der identischen zu produzierenden Bauteile:
 E (u)1: 1x
 E (u)2: 2x
 E (u)3 braucht keine weiteren Einschnitte.

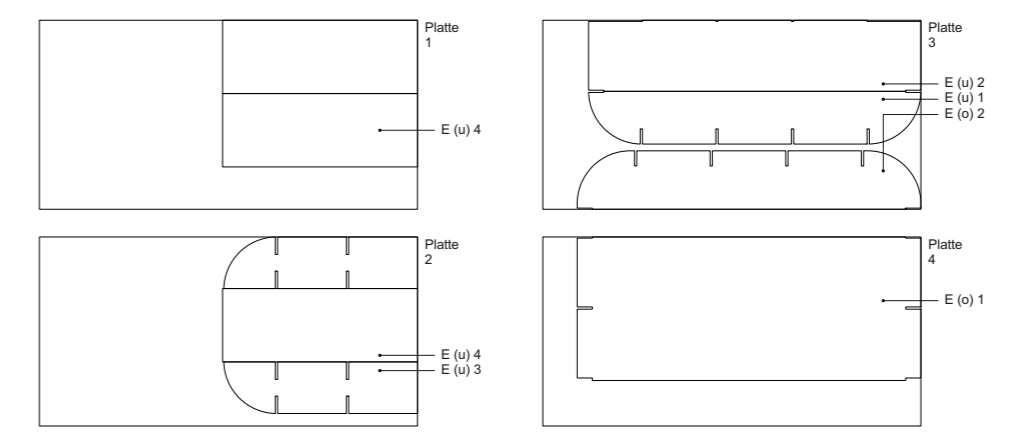
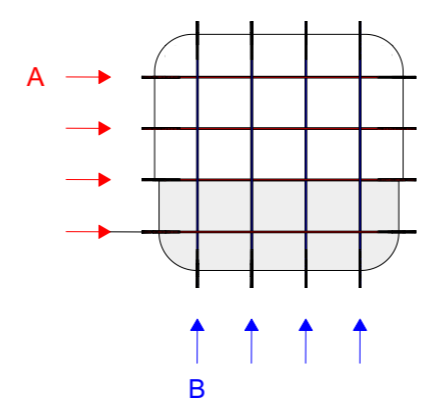
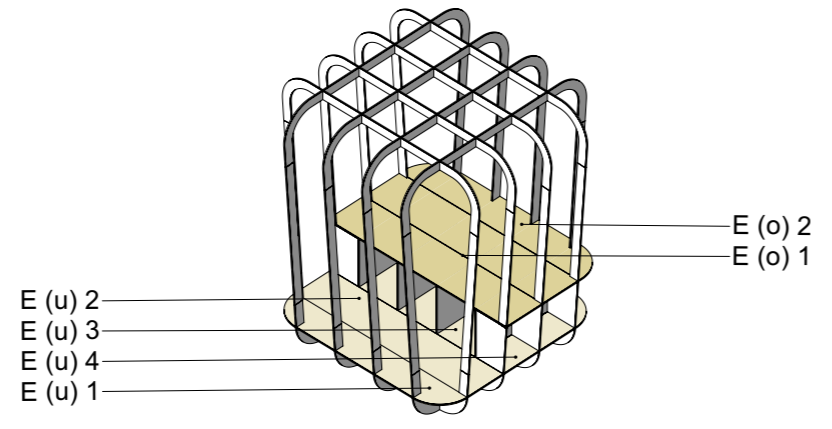

Projekt Titel: Wohnkapsel
 Planinhalt: Bauteil E (u)/(o)
 Planart: Konstruktionszeichnung
 Pl. Nr.: K-09
 Version: 03
 Datum: 28.09.21
 Maßstab: 1:10
 Plangröße: A2
 File: Eu_k009_v03_A2_280921
 Gez.: B, the MoM studio